

	PANORAMIC	CBCT	CEPHALOMETRIC
X-RAY SOURCE			
Tube type	High frequency DC generator		
Total filtration	>2.5 mm Al @ 90 kV		
Mode of operation	Continuous	Pulsed	Continuous
Tube voltage	60 - 85 kVp	90 kVp	60 - 85 kVp
Anodic current	4 - 10 mA	4 - 12 mA	4 - 10 mA
Focal spot	0.5 mm	0.5 mm	0.5 mm
DETECTOR			
Type	CMOS	Flat Panel CMOS	CMOS
FOV and format	260 x 148 mm	ø 40 x 40 mm, ø 60 x 60 mm, ø 80 x 80 mm, ø 110 x 80 mm (nose)	200 x 220 mm, 200 x 180 mm, 240 x 220 mm, 240 x 180 mm
Pixel size/Voxel size	Pixel: 0.100 mm	Voxel: 0.75 mm	Pixel: 0.100 mm
ACQUISITION			
Technique	180° Single scan	360° Single scan	Single scan
Exposure time	16.8 s	4 - 12 s	9 s
Scanning time	16.8 s - 25 s	12 - 30 s	14 s
Programs	Standard, child, Improved Orthogonality Panoramic, bitewings, maxillary sinus, TMJ	Semi-arch, arch, full arch, sinus, ear	Frontal PA, Frontal AP, option: Carpus
Reconstruction time	3 s	29 s	4 s
IMAGE FORMAT			
	DICOM 3.0, JPEG, JPG, BMP, PNG, GIF, TIFF	DICOM 3.0, STL	DICOM 3.0, JPEG, JPG, BMP, PNG, GIF, TIFF
MECHANICAL DATA			
Max footprint dimensions	L 150 x W 110 cm		L 150 x W 172 cm
Height	Max : 235 cm		
Weight	170 kg (PAN)	185 kg (PAN-CBCT)	215 kg (PAN-CEPH)
IEC			
Class and Type	Class I, Type B		
WORKSTATION (included with CBCT)			
CPU	Intel Xeon 2 GHz		
Hard disk	1 TB		
Graphic Processor	NVIDIA (CUDA environnement GPU family)		
RAM	8 GB		
NIC	Dedicated Gb NIC for X-Mind trium connection		
Operating system	Windows 7 professional 64 bits		

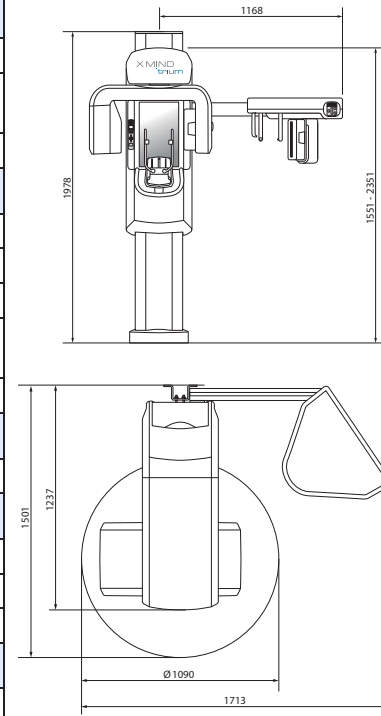

Non contractual document - Ref. SPRO707004.A - Ref. SATELEC03031-062014 - Copyright © 2014 SPRO. All rights reserved. No information or part of this document may be reproduced or transmitted in any form without the prior permission of SPRO.

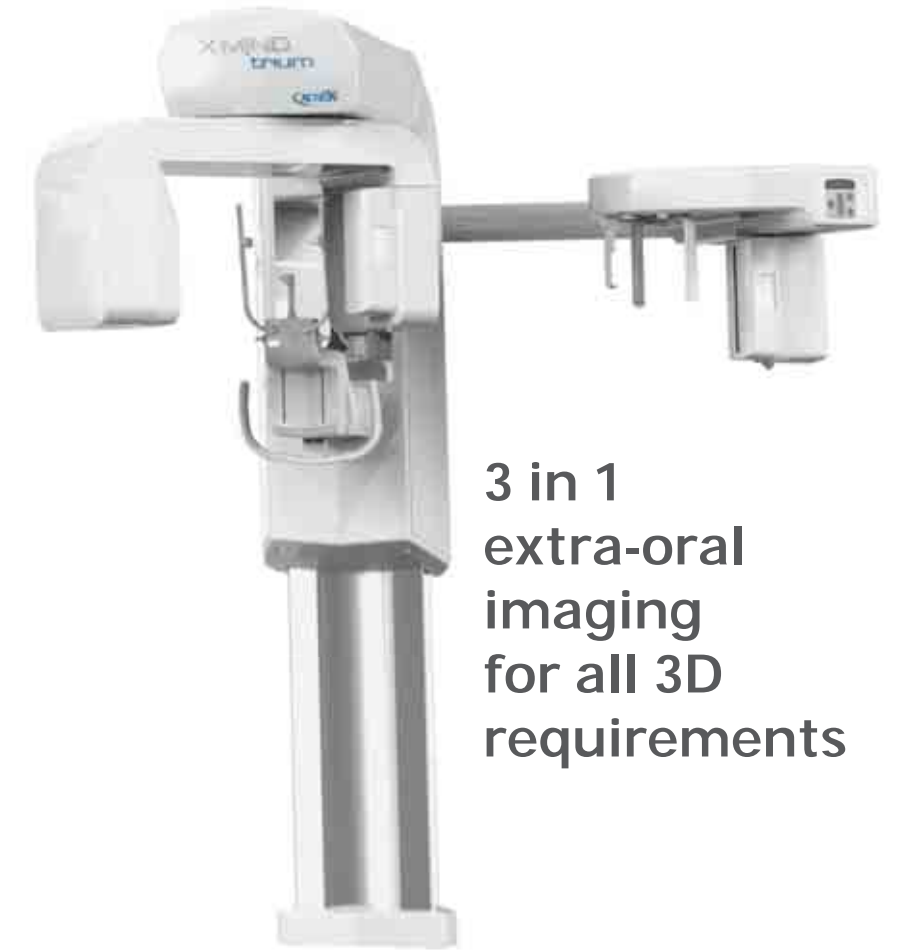
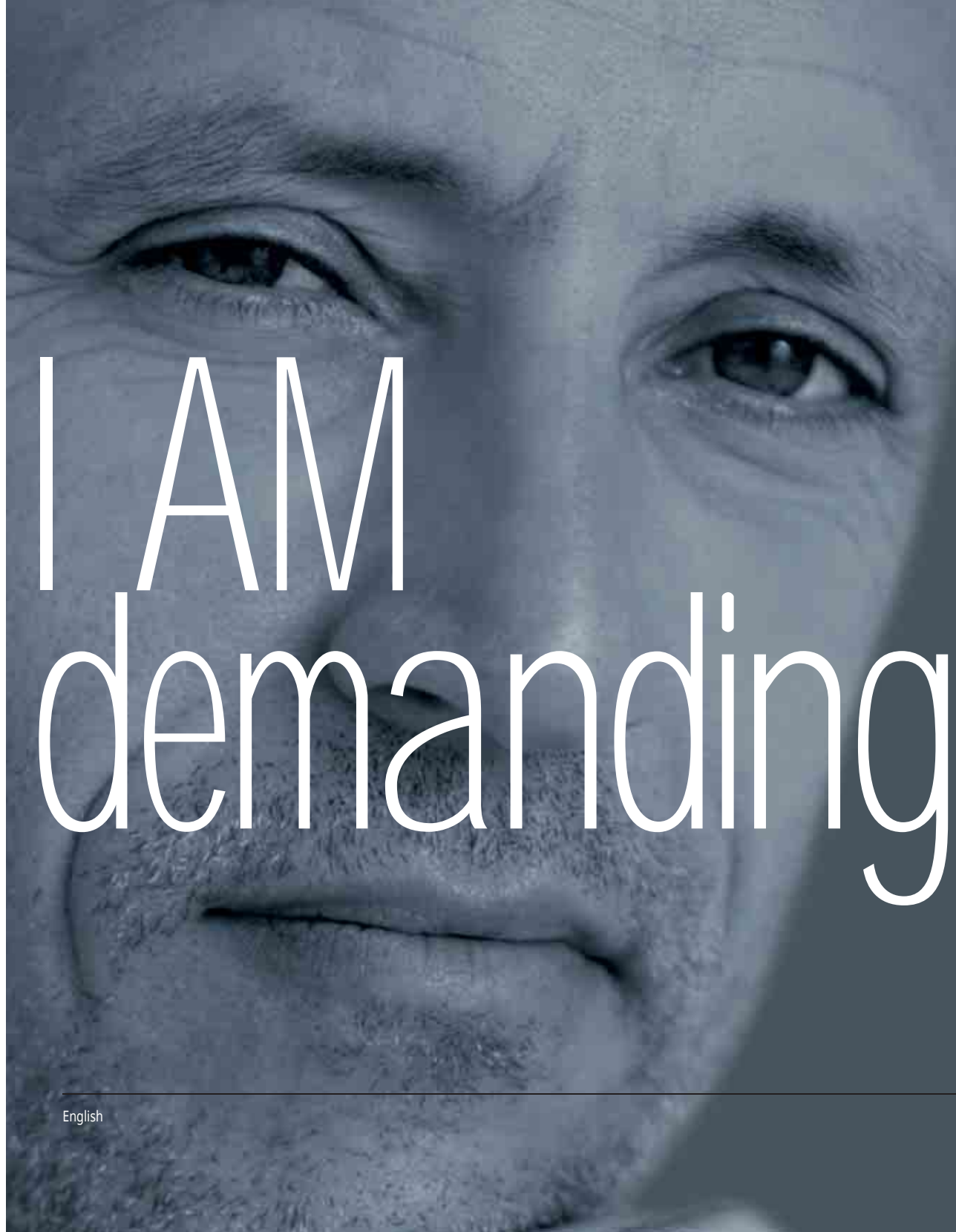

**3 in 1
extra-oral
imaging
for all 3D
requirements**



X MIND
trium

I need 3 Solutions in 1

Because the future has no boundaries

X-Mind® trium which is manufactured by ACTEON® is a digital panoramic imaging system which can be upgraded.

It is designed to provide the optimum level of image quality for superior diagnostic valuation in dental radiology at a minimal dose.

The extensive possibilities of panoramic, cephalometric and 3D acquisition types make it the perfect tool for :

- implant surgery
- orthodontics
- endodontics
- periodontal treatment
- general dentistry

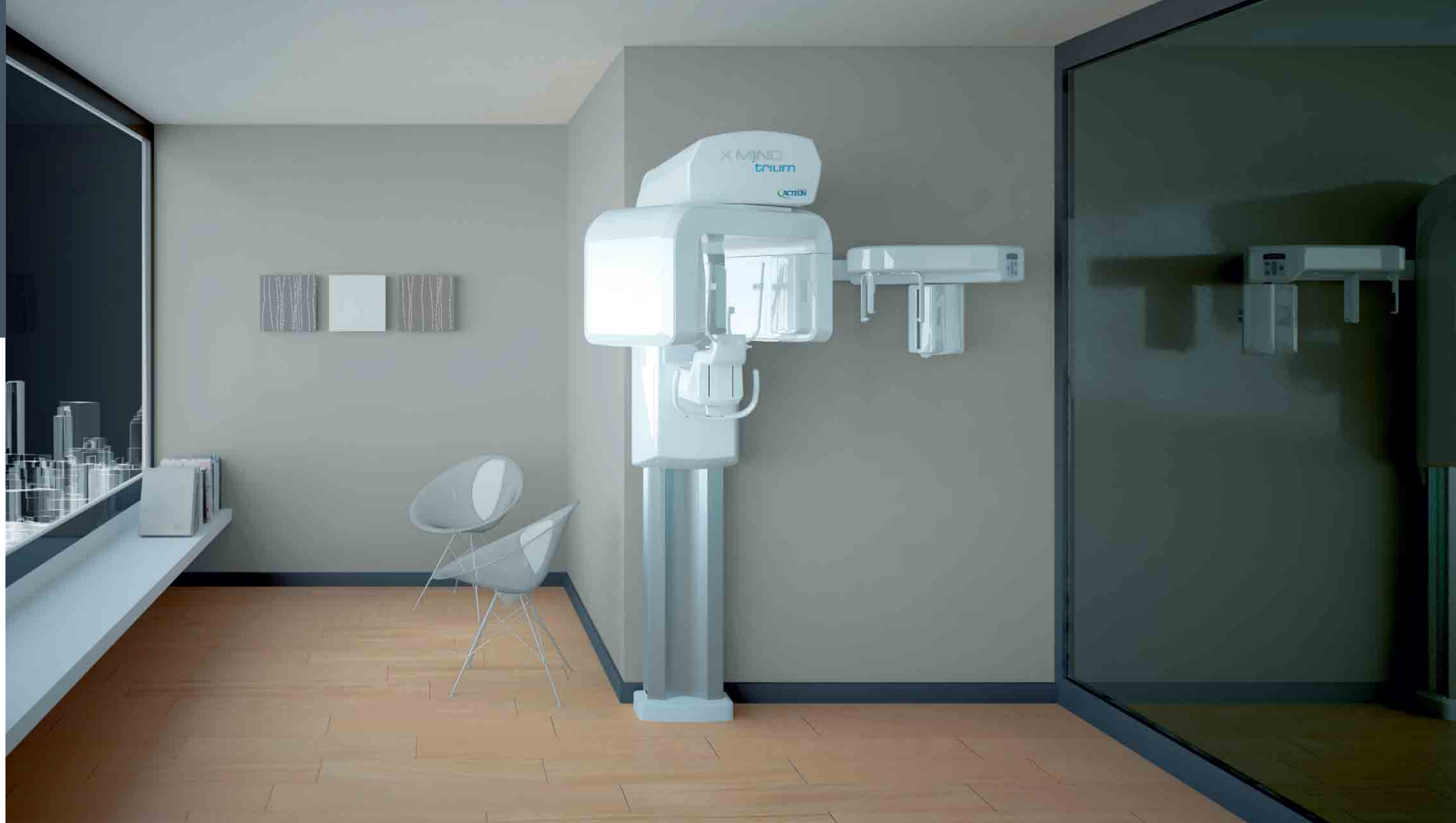

X MIND trium | I want unlimited possibilities

Choose now, upgrade later

X-Mind trium has an extensive range of options and upgrades. There is an X-Mind trium with features and functionalities to suit all your requirements. X-Mind trium will adapt to the ever increasing needs of your clinic by adding 3D imaging or digital cephalometric modalities when you decide it is necessary.



X-Mind trium Pan



X-Mind trium Pan 3D



X-Mind trium Pan Ceph



X-Mind trium Pan Ceph 3D

Ceph and/or 3D upgrade

Ceph Ready

● = option available

X MIND trium | I require no compromise in my 3D

Thanks to X-Mind trium, no need to compromise! ACTEON has developed a high image quality and a wide range of F.O.V.:

- Image definition of 75 μm
- 4 selectable sizes of Field of View (from 40x40 mm to 110x80 mm)

Sharp, Star and ART are the novel cutting edge's software and algorithms techniques for enhanced image post processing.

SHARP™ This novel filtering method stands for Spatial High Amplitude Re-Processing. SHARP reduces streak artefacts and noise levels resulting in a clear, crisp image especially at the boundaries of the HU scale in such areas as airways and bones.

STAR™ The Spatial Technique for Artefact Reduction is perfect for acquisitions with patients who have large crowns or multiple implants. The metal artefacts disappear allowing a clear reading of the image.



Without SHARP



With SHARP

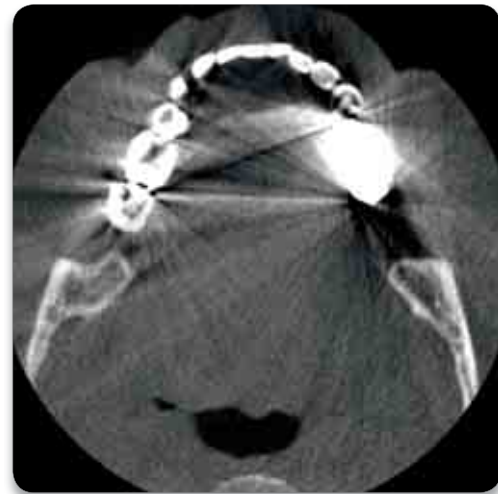

Without STAR



With STAR

ACTEON has a proven track record of innovation through advanced image processing, leading to an excellent image quality for accurate diagnostics and a low dose for the patient, for example:

- Hounsfield unit calibration on CBCT with WhiteFox®. Allows accurate bone density measurement.
- ACE™ technology with SOPIX® and X-Mind unity. Enabling a reduction in dose of approximately 52%
- Cario mode from SOPROLIFE®. Intra-oral camera detecting early stage decay

Minimal dose for the patient

Thanks to the pulsed mode acquisition, the selectable F.O.V. and high sensitivity CMOS sensor, the patient receives a minimal dose for optimal image quality.

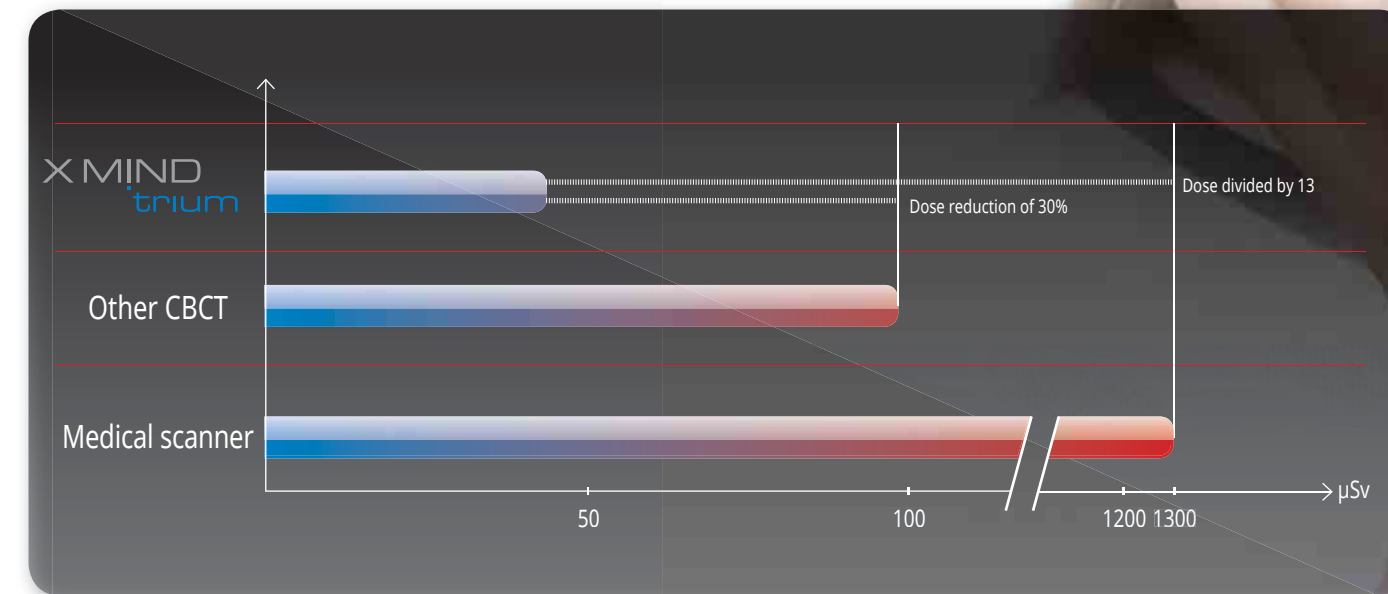

X MIND trium I DEMAND CBCT



Previously few people were able to benefit from the CBCT acquisition. Now it is an essential part of implant planning. However it's precision and the quality of information that it provides make it a prime tool for Periodontics as well as Endodontics. X-Mind triumph provides a full arch examination in one scan with the best diagnostic possibilities for all dentistry specialities.



X MIND trium | CBCT

WIDE CHOICE OF F.O.V.

Selecting the right volume for your examination is the warranty for the patient to get the lowest radiation exposure.



ø 40x40 mm



ø 60x60 mm



ø 80x80 mm



ø 110x80 mm

EFFICIENT WORKFLOW

The F.O.V. and quality selection are made directly on the computer and final positioning can be checked with the help of 3 lasers and an optional scout view. The need for repeated scans for the same patient is eliminated.

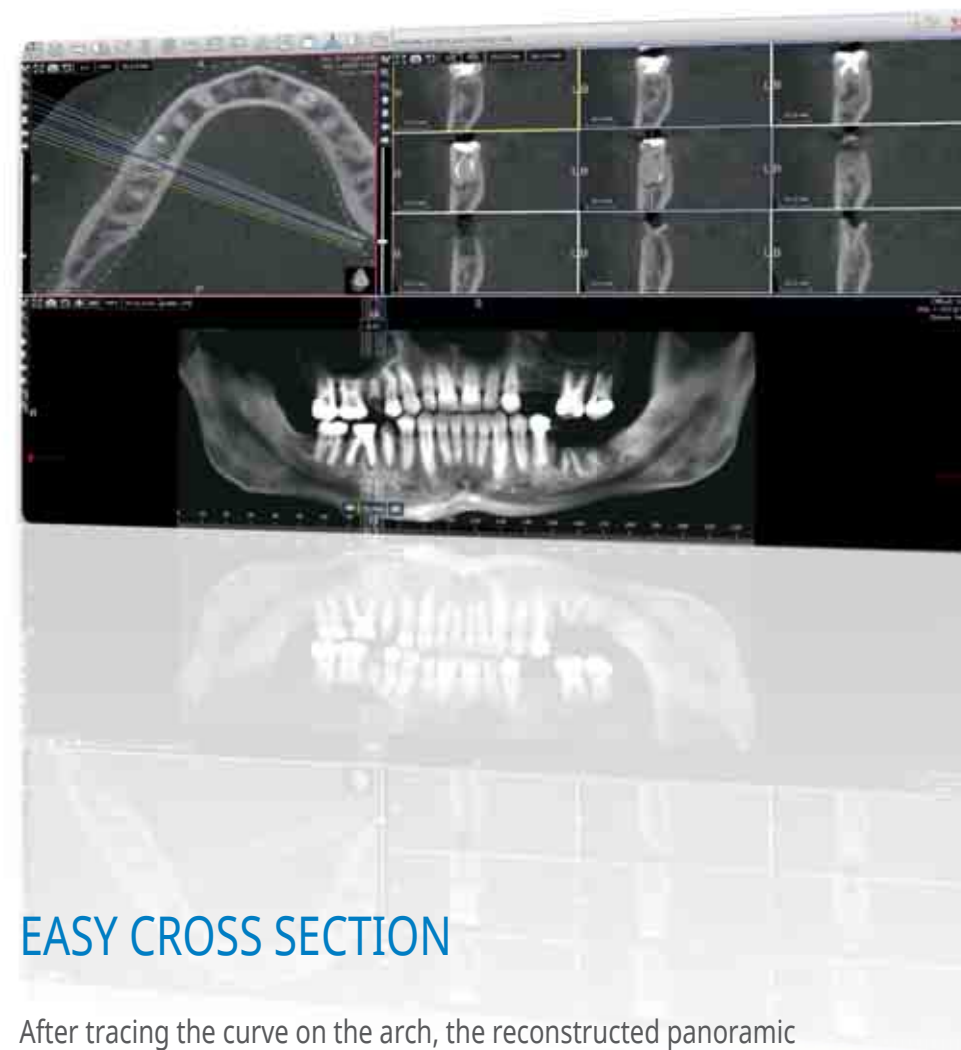

EASY CROSS SECTION

After tracing the curve on the arch, the reconstructed panoramic image can be seen with its cross sections. One click on the area of interest and the cross sections will be displayed clearly revealing the clinical challenges.

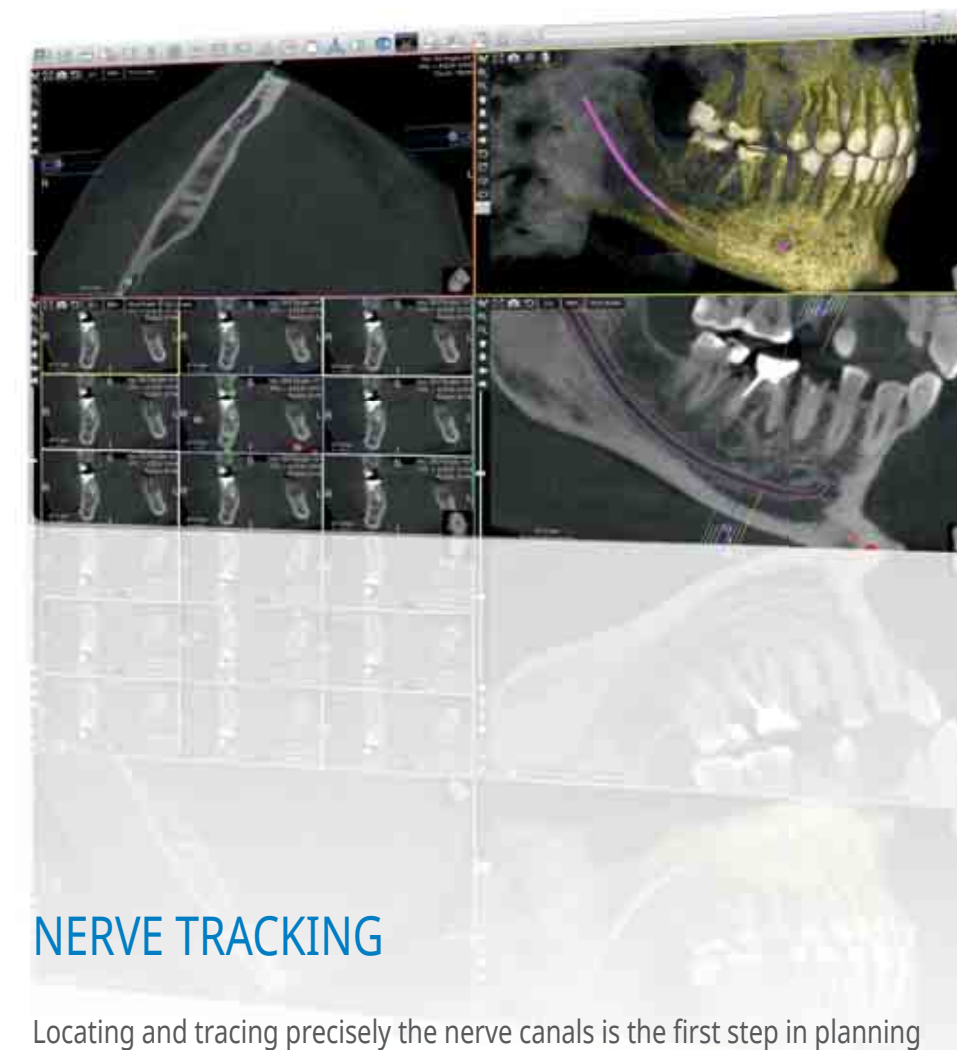

NERVE TRACKING

Locating and tracing precisely the nerve canals is the first step in planning the implant procedure and enables a clear identification of the necessary surgery.

X MIND trium | CBCT

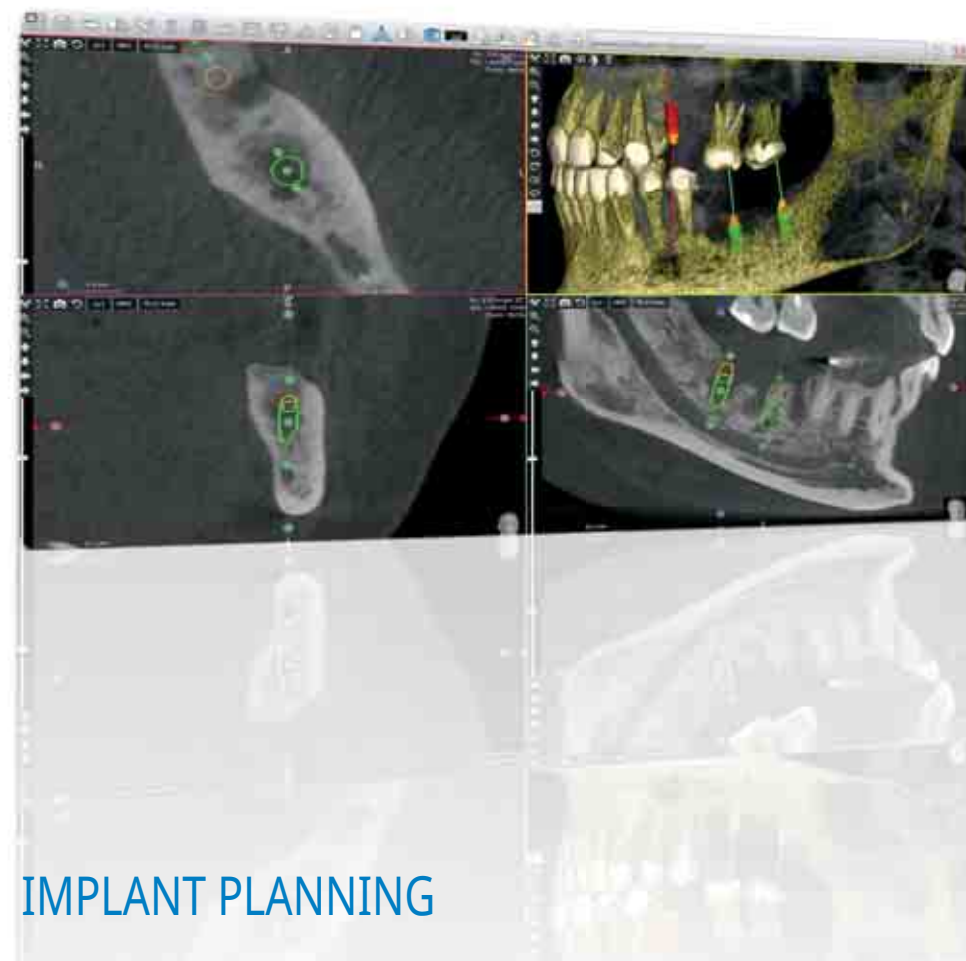

IMPLANT PLANNING

The implant planning program is so intuitive and fast that you can explain the forthcoming surgery to your patient immediately after the acquisition. This information will impress your patient and maximise the chance that they will go ahead with the surgery. X-Mind triumph provides the highest level of accuracy which aids patient safety.

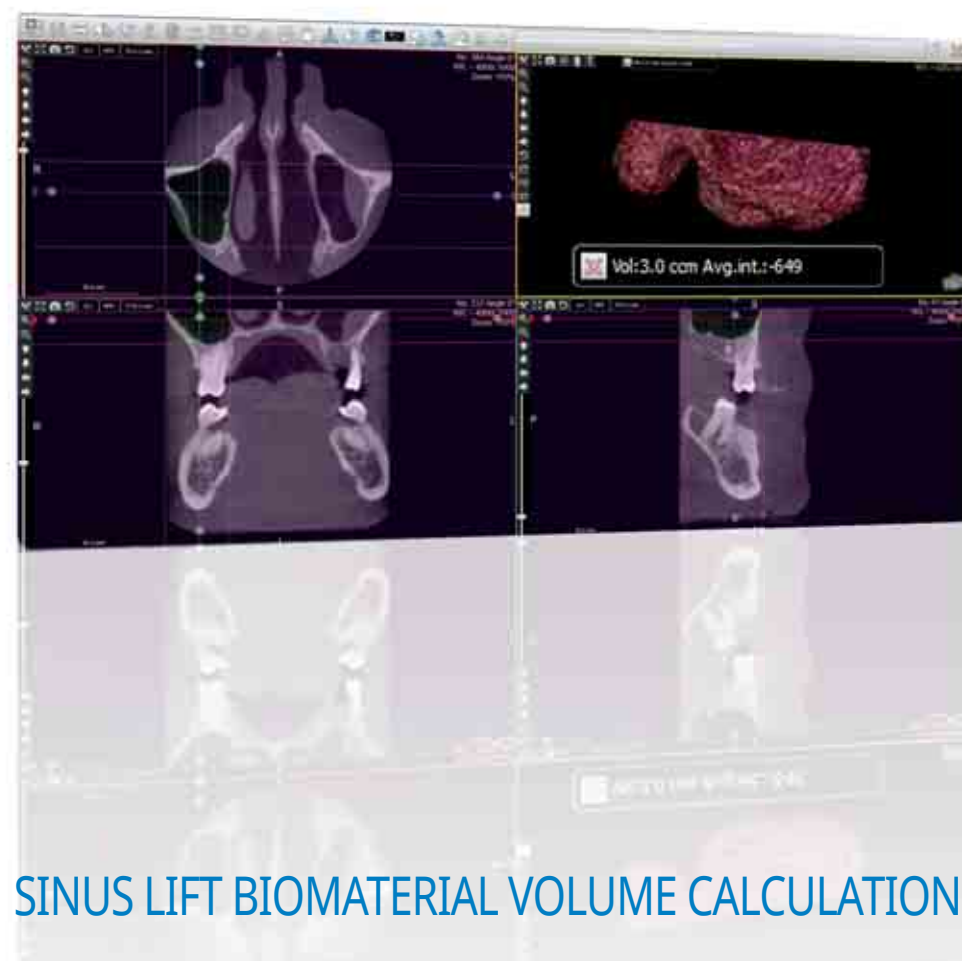

SINUS LIFT BIOMATERIAL VOLUME CALCULATION

Implant planning is so intuitive and fast that you can explain to your patient. ACTEON Imaging Software 3D App offers various measuring tools such as distance, surface and angle measurement but certainly the most advanced one is the volume calculation tool that calculates the volume of biomaterial needed for sinus lift surgery.

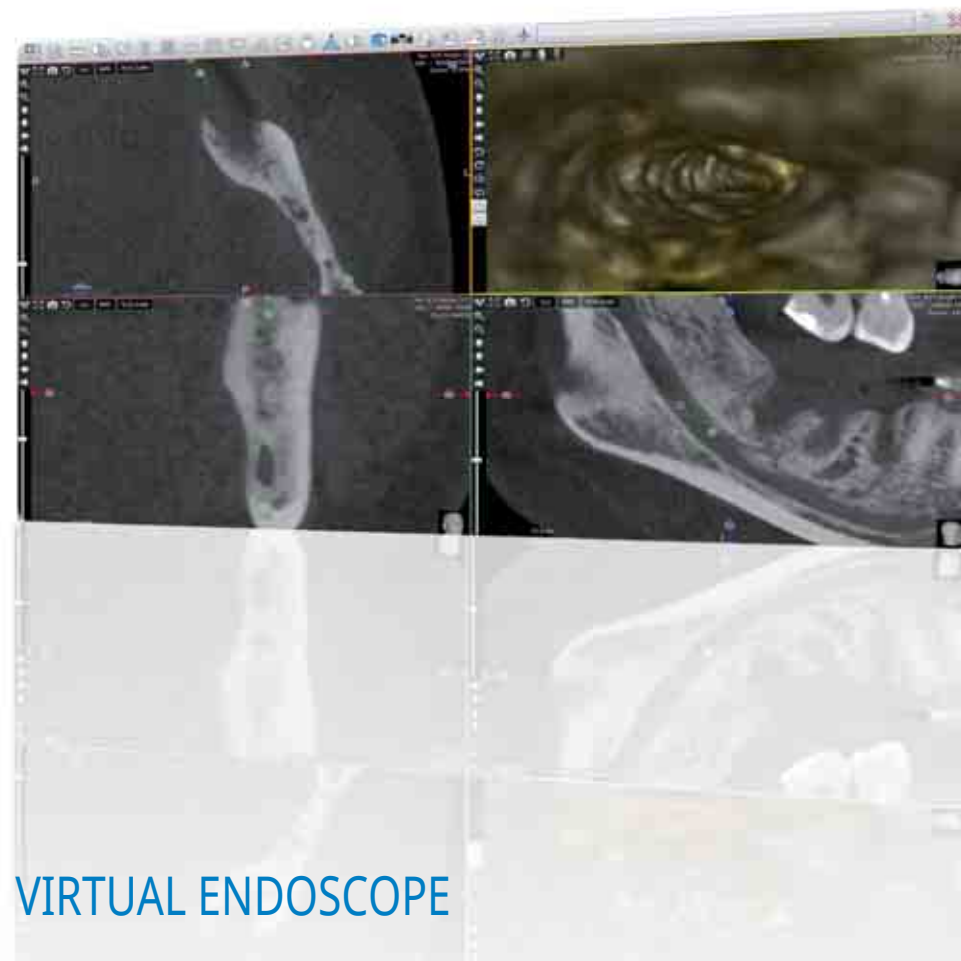

VIRTUAL ENDOSCOPE

Navigate through the airways or the mandibular nerve canal as with an endoscope. You will be amazed by the realism of the volume rendering of this non-intrusive method.

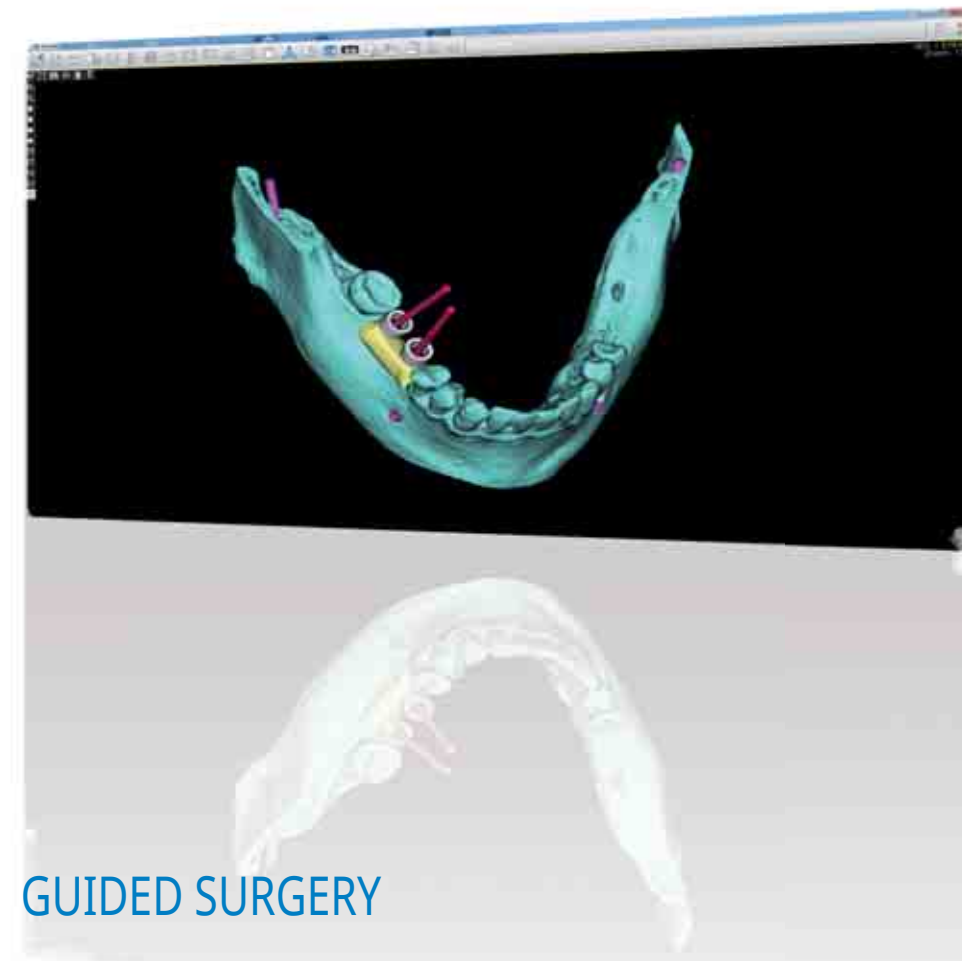

GUIDED SURGERY

ACTEON Imaging Suite can import and export image data generated by X-Mind triumph acquisitions, optical scanners or implant database in STL format so that you have a fully open architecture. With X-Mind triumph, you can transfer data from one software to another and be free to choose the correct software which will enable you to get the best clinical results.



XMIND
trium

I DEMAND PANORAMIC



The dental panoramic radiograph provides a comprehensive view of the patient covering the upper and lower jaw, the facial bones and condyles, the maxillary sinus and nasal turbinates.

As the most widely used method of examination in dentistry, it has been a major focus in the development of X-Mind trium.

X MIND trium | Panoramic

PATIENT CONTENTION

With image details below 100 μm , it is essential that the patient remains still while being examined. ACTEON has designed a unique support system for X-Mind trium that is both comfortable and stable during the acquisition. Motion artefacts will become a thing of the past.



PRECISION IN MOTION

All movements of X-Mind trium benefit from its advanced kinetics. Silent micro-steps motors make acquisitions quieter and more precise than ever. Two translations and one rotation movement ensure that the dental anatomy of every patient can be seen in the highest level of detail on the panoramic image.

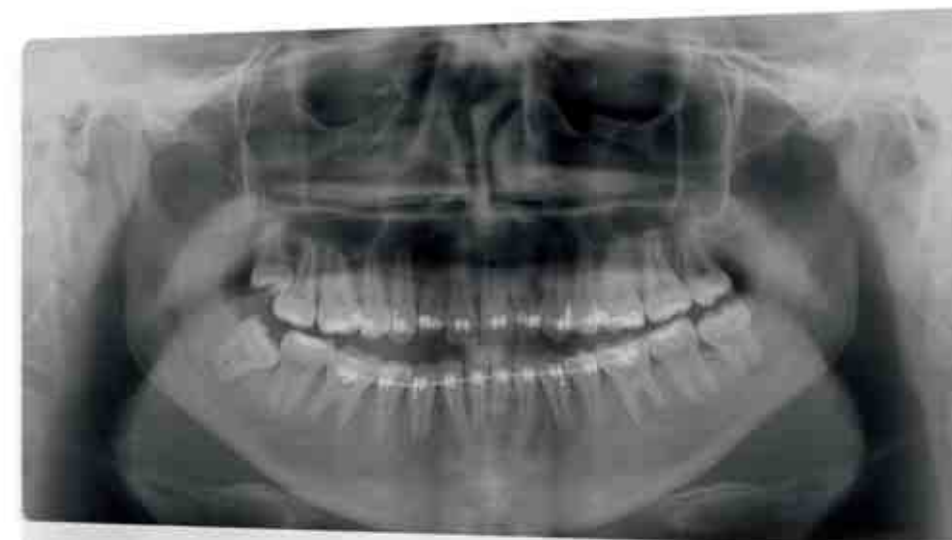

ADULT PANORAMIC

Standard panoramic with the option of having partial right or left view.



CHILD PANORAMIC

Faster acquisition and lower dose.

X MIND trium | Panoramic



IMPROVED ORTHOGONALITY PANORAMIC

X-ray beam perpendicular to the jaw for better orthogonality and reducing overlapping of crowns.

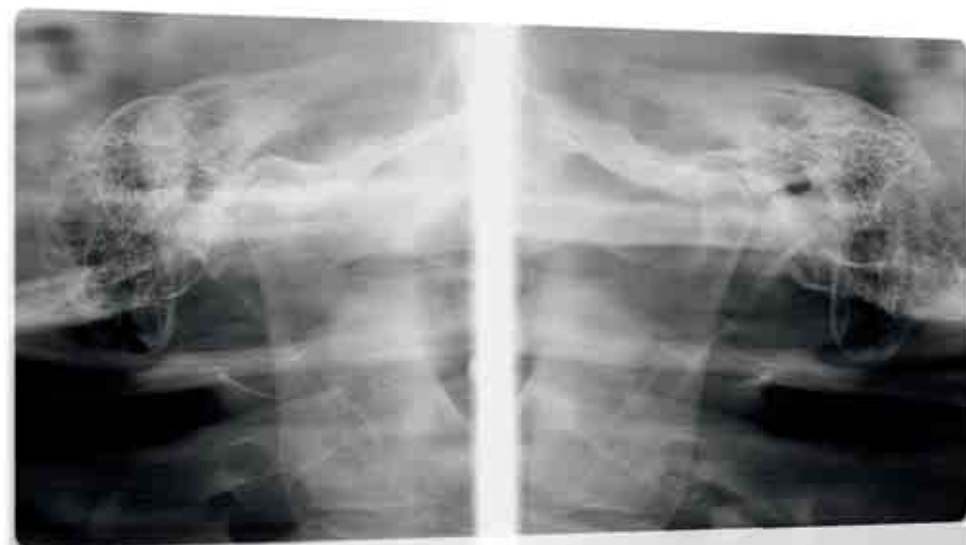

TMJ SECTIONS

Both open and closed mouth images.

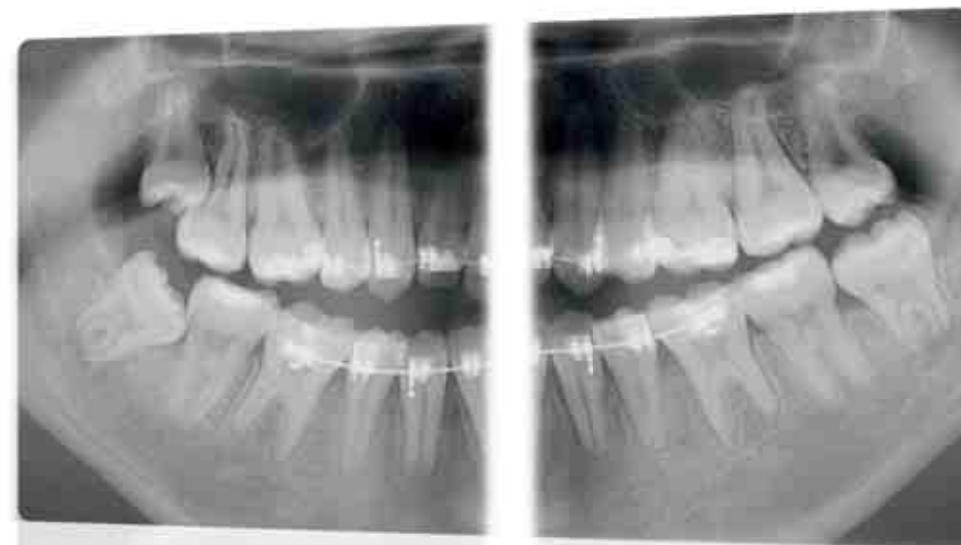

BITEWING

A quick Bitewing image in one shot.



MAXILLARY SINUS

Frontal and lateral views of the maxillary sinus and paranasal area.

X MIND
trium

I DEMAND cephalometric



The expertise of ACTEON in 2D radiology has led to the design of a cephalometric arm aiming to provide low dose, sharp images and patient comfort.

X-Mind trium is the ideal partner to every Orthodontics specialist and Maxillo-facial surgeon.

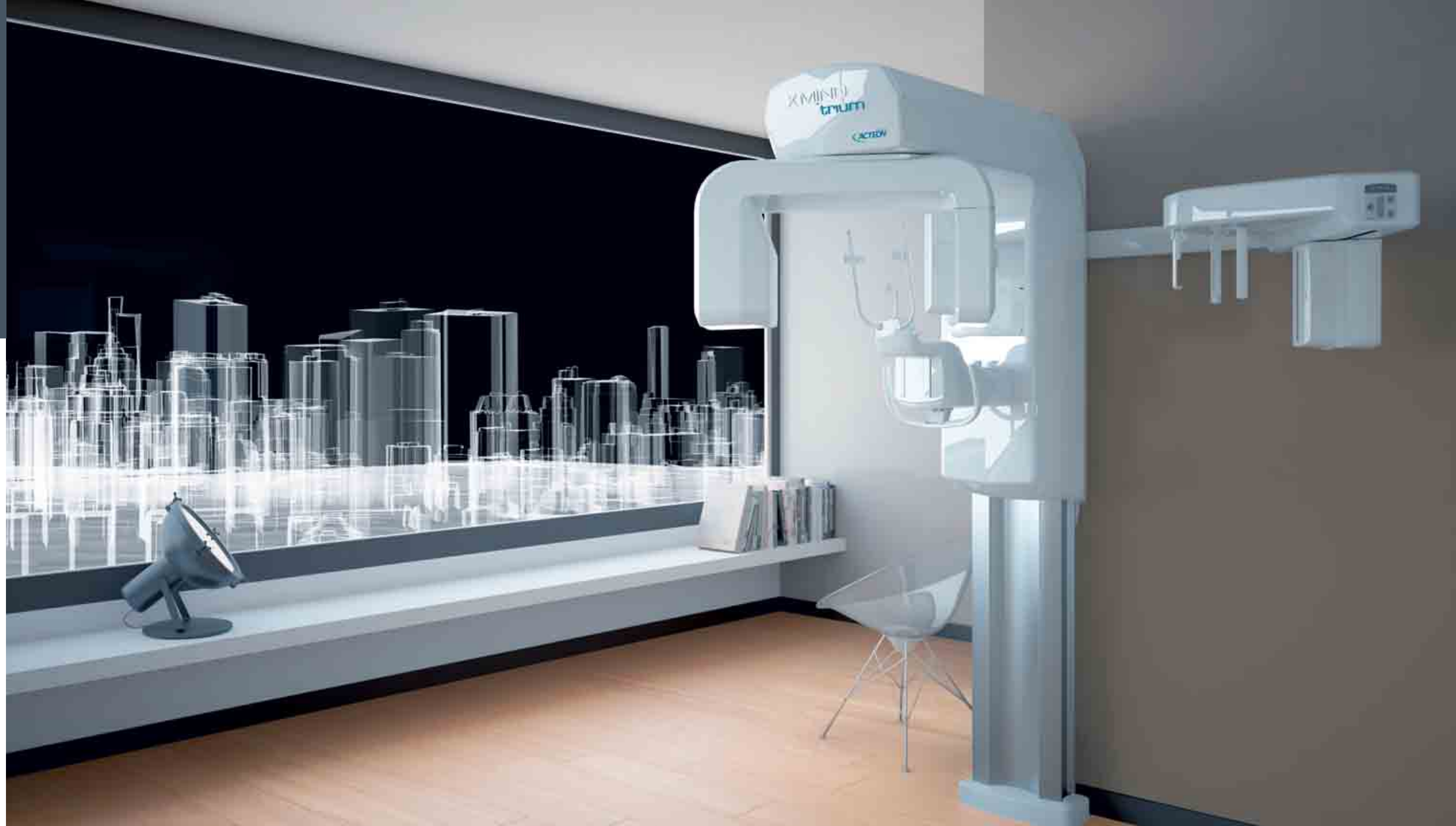

X MIND trium | Cephalometric

X-Mind trium can be equipped as either a single or a dual sensor system for the most efficient workflow.



Thanks to its patented cinematic and collimation, the patient positioning is easier than on other machines. The patient is not bothered with the moving secondary collimation during the Cephalometric acquisition.



☒ Right or left:
install the cephalometric's arm
where it suits best.



LATERAL FULL SKULL



POSTERIOR-ANTERIOR



CARPUS VIEW



ACTEON suite imaging

I demand no limit

ACTEON has designed ACTEON Imaging Suite to enable your imaging workflow to run more efficiently.

- Superior design
- Clean lines
- User friendly
- Open architecture
- Full integration
- Advanced functionalities

User friendly

Largely inspired by leading B2C companies, AIS brings a new level of user friendliness to the field of dental imaging. Clear and intuitive icons are displayed according to which devices are connected. Menus and tools are clearly identified allowing a rapid learning curve and fast navigation. Acquiring a 2D image requires only one click and is instantly visible.

ACTEON suite imaging

I don't want any compromise

Compatibility

ACTEON Imaging Suite is Windows and Mac compatible. It can be linked to most Practice Management Software.

AIS can be installed on the clinic's computers sharing devices as well as common centralized database.

Comfort of integration

There is no need to use multiple imaging software to handle each part of your equipment;

AIS will connect to all ACTEON imaging products as well as to other digital devices with the TWAIN* function.

Comprehensive functionalities

Each image can be treated, filtered, annotated and measured with a large range of tools.

They can be part of a report, exported in different formats, printed or sent via email.

AIS provides you with a unique Implant Library**, video function and dose traceability.

* On the condition that the device is TWAIN compatible itself.

** Ask for a list of implant manufacturers.

